



DESCRIPTION

VA7493HF

24V electromotive proportional actuator (INPUT signal 0-10V DC / 0(4)-20mA) to drive Pettinaroli's **PICV 92H (1 1/2" and 2")**. Maximum stroke 8,7 mm.

Equipped with valve stroke detection system and feedback (0-10V DC) to verify the position of the actuator at every moment.

Connection M30x1,5 ring nut and adaptable to Pettinaroli's standards through specific adaptor.

DIMENSIONI

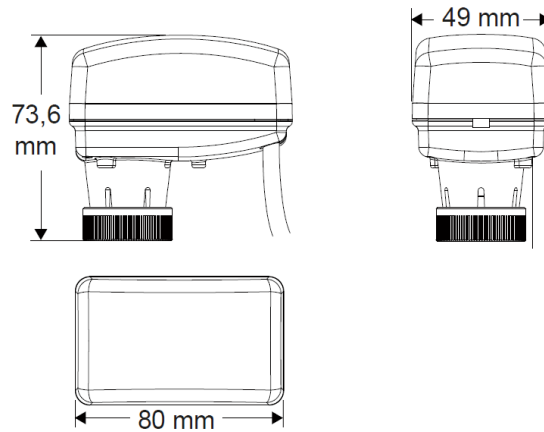

TECHNICAL FEATURES

Type	Proportional	Visual position indicator	LED
Supply voltage	24V DC/AC +/- 15% 50/60 Hz	Configuration of the actuator	By DIP switches
Power consumption	1,5 W / 2,5 VA	Temperatura massima fluido	95 °C
Control signal	0(2)-10V DC / 0(4)-20mA	Temperature ambient range	0 °C / 50 °C (non condensing)
Feedback signal	0-10V DC	Umidity ambient range	10% / 90% RH (non condensing)
Max stroke	8,7 mm	IP class	IP54
Running time	8 s/mm	Connection cable	4 x 0,35 mm ²
Actuating force	200N	Cable lenght	2 m
Impedenza d'ingresso tensione	> 100 kΩ	Adaptor	0A7493 (included)
Impedenza d'ingresso corrente	500 Ω	Color	White body <u>with black translucent lid</u>

The VA7493HF electromotive actuator is used to drive in proportional mode pressure independent control valves controlling heating and cooling system by means of BMS (Building Management System) or suitable thermostat able to manage 0-10V signals. For more details about the wiring see the specific chapter below.

In order to install the actuator on Pettinaroli's **92H (1 1/2" and 2")** valves it is necessary to use a suitable adapter (**0A7493**) which is included with the actuator.

APPROVALS



Pettinaroli UK - Riverside, Unit K Austin Way Hamstead Industrial Estate Birmingham B42 1DU - UK

ELECTRICAL CONNECTIONS

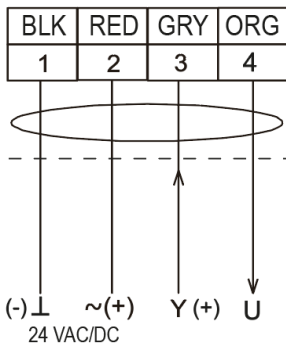

OPERATING STATUS INDICATOR

The VA7493HF 24 V electromotive actuator has a double colour LED (green/red) indicating its operating status as shown by the table below

OFF		No power supply
Green blinking		Moving to position
Green steady on		Position reached
Red blinking		Calibration cycle
Red fast blinking		Valve stem closing failure
Red steady on		4-20mA or 2-10VDC lost

INSTALLATION

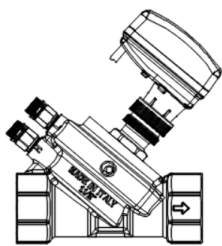

Fig. 1

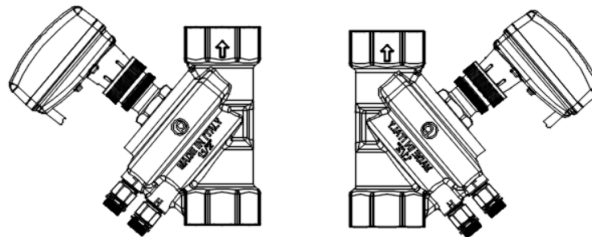

Fig. 2

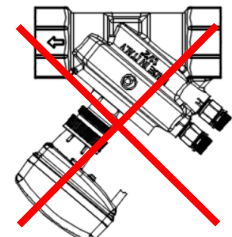
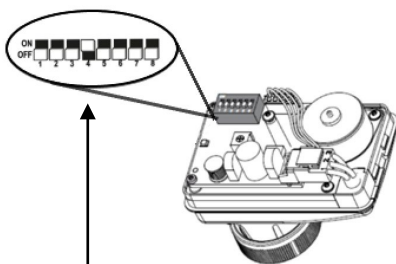

Fig. 3

- For electrical safety reasons the VA7493HF electromotive actuator has to be installed as shown by pictures 1 and 2. The upside down installation shown in picture 3 must be avoided. Always install the actuator with the pin in fully retracted position;
- Do not power the actuator if not installed on the valve;
- Tighten the connecting ring by hand only. Do not use any tools;
- Keep a clear space of 15 cm over the actuator to access it, if required.

SETTING

DIP SWITCH 1-2-3-6



Default configuration

OPTIONS DIP SWITCH			
<input type="checkbox"/> 0-10 VDC	<input type="checkbox"/> 0.5 VDC	<input type="checkbox"/> 5-10 VDC	<input type="checkbox"/> 2-10 VDC
<input type="checkbox"/> 0-20 mA	<input type="checkbox"/> 4-20 mA	<input type="checkbox"/> mA	<input type="checkbox"/> Eq%
<input type="checkbox"/> DA	<input type="checkbox"/> RA	<input type="checkbox"/> NOT USED	<input type="checkbox"/> NOT USED
<input type="checkbox"/> LIN	<input type="checkbox"/> NOT USED	<input type="checkbox"/> NOT USED	<input type="checkbox"/> NOT USED
<input type="checkbox"/> VDC	<input type="checkbox"/> NOT USED	<input type="checkbox"/> NOT USED	<input type="checkbox"/> NOT USED
<input type="checkbox"/> NOT USED	<input type="checkbox"/> NOT USED	<input type="checkbox"/> NOT USED	<input type="checkbox"/> NOT USED
1: CONTROL SIGNAL RANGE	5: CURVE	6: SIGNAL TYPE	7: NOT USED
2: CONTROL SIGNAL RANGE	8: NOT USED		
3:			
4: ACTION			

The VA7493HF 24 V electromotive proportional actuator has 8 switch ON/OFF which allow the actuator set-up according to operation request.

The control signal (voltage V DC or current mA) is set through switch n° 1-2-3.

The control signal type is selected by switch n°6.

The default position of switches n°1-2-3-6 is OFF.

DIP SWITCH 4

The switch n°4 allows the user to change the actuator action according to figital input:

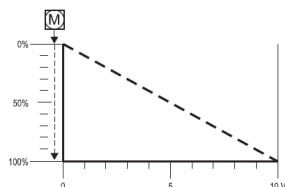

switch n°4 – OFF: Direct action – When the signal increases, the valve closes. 0 V valve open, 10 V valve closed

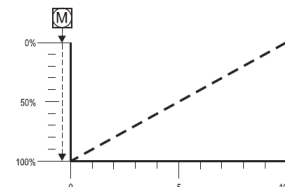

switch n°4 – ON (default): Reverse action – When the signal increases, the valve opens. 0 V valve closed, 10 V valve open

DIP SWITCH 5

The switch n°5 sets the actuator control characteristic in order to get a LINEAR response (switch n°5 – OFF) or EQUAL PERCENTAGE one (switch n°5 - ON) of the actuator. In default switch n°5 is set to ON.